

Rogue

ES 181iP PRO, ES 201iP PRO

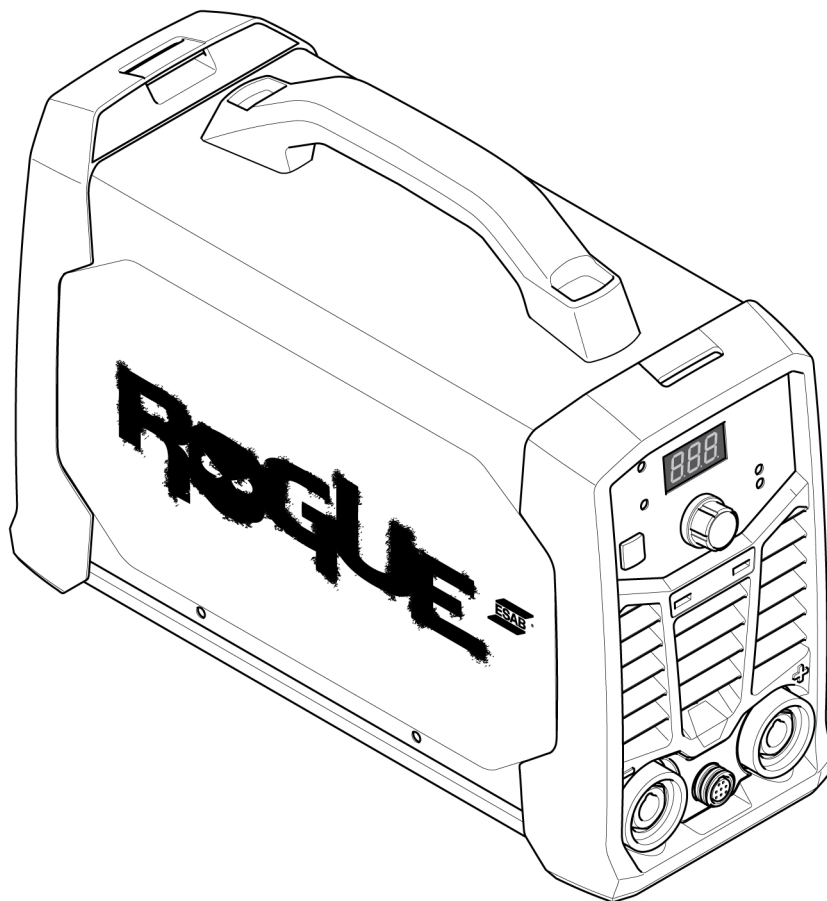

Instruction manual



EU DECLARATION OF CONFORMITY

According to:

The Low Voltage Directive 2014/35/EU; The EMC Directive 2014/30/EU;
The RoHS Directive 2011/65/EU; The Ecodesign Directive 2009/125/EC

Type of equipment

Arc welding power source

Type designation

ES 181iP Pro from serial number HA427 YY XX XXXX
ES 201iP Pro from serial number HA428 YY XX XXXX

X and Y represents digits, 0 to 9 in the serial number, where YY indicates year of production.

Brand name or trademark

ESAB

Manufacturer or his authorised representative established within the EEA

ESAB AB
Lindholmsallén 9, Box 8004, SE-402 77 Göteborg, Sweden
Phone: +46 31 50 90 00, www.esab.com

The following EN standards and regulations in force within the EEA has been used in the design:

| | |
|------------------------------|---|
| EN IEC 60974-1:2022+A11:2022 | Arc Welding Equipment - Part 1: Welding power sources |
| EU reg. no. 2019/1784 | Ecodesign requirements for welding equipment pursuant to Directive 2009/125/EC |
| EN IEC 60974-10:2021 | Arc Welding Equipment - Part 10: Electromagnetic compatibility (EMC) requirements |

Additional Information:

Restrictive use, Class A equipment, intended for use in locations other than residential.
ES 181iP Pro, ES 201iP Pro are part of ESAB Rogue product family

By signing this document, the undersigned declares as manufacturer, or the manufacturer's authorised representative established within the EEA, that the equipment in question complies with the safety and environmental requirements stated above.

Place/Date

Gothenburg
2024-09-04

Signature

Peter Burchfield
General Manager, Equipment Solutions



TABLE OF CONTENTS

| | | |
|----------|--|-----------|
| 1 | SAFETY | 4 |
| | 1.1 Meaning of symbols | 4 |
| | 1.2 Safety precautions | 4 |
| 2 | INTRODUCTION | 7 |
| | 2.1 Equipment | 7 |
| 3 | TECHNICAL DATA | 8 |
| 4 | INSTALLATION | 10 |
| | 4.1 Location | 10 |
| | 4.2 Lifting instructions | 10 |
| | 4.3 Mains supply | 11 |
| 5 | OPERATION | 13 |
| | 5.1 Connections and control devices | 13 |
| | 5.2 Connecting welding and return cables | 13 |
| | 5.3 Turning the power on/off | 14 |
| | 5.4 Fan control | 14 |
| | 5.5 Thermal protection | 14 |
| | 5.6 Functions and symbols | 14 |
| | 5.7 Setting panel | 16 |
| | 5.8 Remote control | 16 |
| 6 | MAINTENANCE | 17 |
| | 6.1 Routine maintenance | 17 |
| | 6.2 Cleaning the power source | 17 |
| 7 | TROUBLESHOOTING | 19 |
| 8 | ORDERING SPARE PARTS | 20 |
| | DIAGRAM | 21 |
| | ORDERING NUMBERS | 23 |
| | ACCESSORIES | 24 |

1 SAFETY

1.1 Meaning of symbols

As used throughout this manual: Means Attention! Be Alert!

**DANGER!**

Means immediate hazards which, if not avoided, will result in immediate, serious personal injury or loss of life.

**WARNING!**

Means potential hazards which could result in personal injury or loss of life.

**CAUTION!**

Means hazards which could result in minor personal injury.

**WARNING!**

Before use, read and understand the instruction manual and follow all labels, employer's safety practices and Safety Data Sheets (SDSs).



1.2 Safety precautions

Users of ESAB equipment have the ultimate responsibility for ensuring that anyone who works on or near the equipment observes all the relevant safety precautions. Safety precautions must meet the requirements that apply to this type of equipment. The following recommendations should be observed in addition to the standard regulations that apply to the workplace.

All work must be carried out by trained personnel well-acquainted with the operation of the equipment. Incorrect operation of the equipment may lead to hazardous situations which can result in injury to the operator and damage to the equipment.

1. Anyone who uses the equipment must be familiar with:
 - its operation
 - location of emergency stops
 - its function
 - relevant safety precautions
 - welding and cutting or other applicable operation of the equipment
2. The operator must ensure that:
 - no unauthorised person is stationed within the working area of the equipment when it is started up
 - no-one is unprotected when the arc is struck or work is started with the equipment
3. The workplace must:
 - be suitable for the purpose
 - be free from drafts
4. Personal safety equipment:
 - Always wear recommended personal safety equipment, such as safety glasses, flame-proof clothing, safety gloves
 - Do not wear loose-fitting items, such as scarves, bracelets, rings, etc., which could become trapped or cause burns

5. General precautions:

- Make sure the return cable is connected securely
- Work on high voltage equipment **may only be carried out by a qualified electrician**
- Appropriate fire extinguishing equipment must be clearly marked and close at hand
- Lubrication and maintenance must **not** be carried out on the equipment during operation

If equipped with ESAB cooler

Use ESAB approved coolant only. Non-approved coolant might damage the equipment and jeopardize product safety. In case of such damage, all warranty undertakings from ESAB cease to apply.

For ordering information, see the "ACCESSORIES" chapter in the instruction manual.

**WARNING!**

Arc welding and cutting can be injurious to yourself and others. Take precautions when welding and cutting.

**ELECTRIC SHOCK - Can kill**

- Install and ground the unit in accordance with instruction manual.
- Do not touch live electrical parts or electrodes with bare skin, wet gloves or wet clothing.
- Insulate yourself from work and ground.
- Ensure your working position is safe

**ELECTRIC AND MAGNETIC FIELDS - Can be dangerous to health**

- Welders having pacemakers should consult their physician before welding. EMF may interfere with some pacemakers.
- Exposure to EMF may have other health effects which are unknown.
- Welders should use the following procedures to minimize exposure to EMF:
 - Route the electrode and work cables together on the same side of your body. Secure them with tape when possible. Do not place your body between the torch and work cables. Never coil the torch or work cable around your body. Keep welding power source and cables as far away from your body as possible.
 - Connect the work cable to the workpiece as close as possible to the area being welded.

**FUMES AND GASES - Can be dangerous to health**

- Keep your head out of the fumes.
- Use ventilation, extraction at the arc, or both, to take fumes and gases away from your breathing zone and the general area.

**ARC RAYS - Can injure eyes and burn skin**

- Protect your eyes and body. Use the correct welding screen and filter lens and wear protective clothing.
- Protect bystanders with suitable screens or curtains.

**NOISE - Excessive noise can damage hearing**

Protect your ears. Use earmuffs or other hearing protection.

MOVING PARTS - Can cause injuries



- Keep all doors, panels, guards, and covers closed and securely in place.
- Have only qualified people remove covers for maintenance and troubleshooting as necessary.



- Keep hands, hair, loose clothing and tools away from moving parts.
- Reinstall panels or covers and close doors when service is finished and before starting the unit.

FIRE HAZARD



- Sparks (spatter) can cause fire. Make sure that there are no inflammable materials nearby.
- Do not use on closed containers.

HOT SURFACE - Parts can burn



- Do not touch parts bare handed.
- Allow cooling period before working on equipment.
- To handle hot parts, use proper tools and/or insulated welding gloves to prevent burns.



CAUTION!

This product is solely intended for arc welding.



WARNING!

Do not use the power source for thawing frozen pipes.



CAUTION!

Class A equipment is not intended for use in residential locations where the electrical power is provided by the public low-voltage supply system. There may be potential difficulties in ensuring electromagnetic compatibility of class A equipment in those locations, due to conducted as well as radiated disturbances.

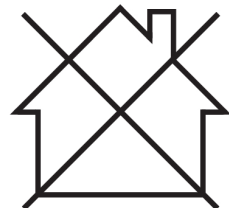

NOTE!

Dispose of electronic equipment at the recycling facility!

In observance of European Directive 2012/19/EC on Waste Electrical and Electronic Equipment and its implementation in accordance with national law, electrical and/or electronic equipment that has reached the end of its life must be disposed of at a recycling facility.

As the person responsible for the equipment, it is your responsibility to obtain information on approved collection stations.

For further information contact the nearest ESAB dealer.

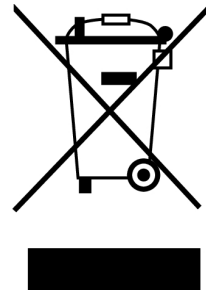

ESAB has an assortment of welding accessories and personal protection equipment for purchase. For ordering information contact your local ESAB dealer or visit us on our website.

2 INTRODUCTION

Rogue ES 181iP PRO, ES 201iP PRO is an inverter-based power source intended for MMA / SMAW / Stick, MMA pulse, TIG / GTAW and TIG pulse welding.

ESAB accessories for the product can be found in the "ACCESSORIES" chapter of this manual.

2.1 Equipment

Rogue ES 181iP PRO, ES 201iP PRO includes:

- Power source
- Work clamp leadset
- Electrode holder leadset
- Shoulder strap
- Safety manual
- Quick start guide

3 TECHNICAL DATA

| | Rogue ES 201iP PRO | | Rogue ES 181iP PRO | |
|--|--------------------------------|--------------------------------|--------------------------------|--------------------------------|
| Outlet voltage | 230 V \pm 15% 1~ 50/60 Hz | 115 V \pm 15% 1~ 50/60 Hz | 230 V \pm 15% 1~ 50/60 Hz | 115 V \pm 15% 1~ 50/60 Hz |
| Primary current | | | | |
| I_{max} MMA / SMAW / Stick | 30 A | 29 A | 26 A | 29 A |
| I_{max} Live TIG / GTAW | 19.5 A | 24 A | 16.5 A | 24 A |
| No-load power demand when in energy saving mode | 50 W | 50 W | 50 W | 50 W |
| Setting range | | | | |
| MMA / SMAW / Stick | 20-200 A | 20-110 A | 20-180 A | 20-110 A |
| Live TIG / GTAW | 10-200 A | 10-140 A | 10-180 A | 10-140 A |
| Permissible load at MMA / SMAW / Stick | | | | |
| 25% duty cycle | 200 A / 28 V | 110 A / 24.4 V | 180 A / 27.2 V | 110 A / 24.4 V |
| 60% duty cycle | 129 A / 25.2 V | 70 A / 22.8 V | 116 A / 24.6 V | 70 A / 22.8 V |
| 100% duty cycle | 100 A / 24 V | 55 A / 22.2 V | 90 A / 23.6 V | 55 A / 22.2 V |
| Permissible load at Live TIG / GTAW | | | | |
| 25% duty cycle | 200 A / 18 V | 140 A / 15.6 V | 180 A / 17.2 V | 140 A / 15.6 V |
| 60% duty cycle | 129 A / 15.2 V | 90 A / 13.6 V | 116 A / 14.6 V | 90 A / 13.6 V |
| 100% duty cycle | 100 A / 14 V | 70 A / 12.8 V | 90 A / 13.6 V | 70 A / 12.8 V |
| Apparent power I_2 at maximum current | 6.9 kVA | 3.3 kVA | 6 kVA | 3.3 kVA |
| Active power I_2 at maximum current | 6.8 kW | 3.26 kW | 5.94 kW | 3.26 kW |
| Power factor at maximum current | | | | |
| Live TIG / GTAW | 0.99 | 0.99 | 0.99 | 0.99 |
| MMA / SMAW / Stick | 0.99 | 0.99 | 0.99 | 0.99 |
| Efficiency at maximum current | | | | |
| MMA / SMAW / Stick | 82% | 82% | 82% | 82% |
| Live TIG / GTAW | 82% | 82% | 82% | 82% |
| Open-circuit voltage U_0 max | | | | |
| VRD 35 V deactivated | 78 V DC | 78 V DC | 78 V DC | 78 V DC |

| | Rogue ES 201iP PRO | | Rogue ES 181iP PRO | |
|--|-------------------------------------|----------------------------------|-------------------------------------|----------------------------------|
| VRD 35 V activated | <30 V | <30 V | <30 V | <30 V |
| Operating temperature | -10 to +40 °C (+14 to 104 °F) | -10 to +40 °C (+14 to 104 °F) | -10 to +40 °C (+14 to 104 °F) | -10 to +40 °C (+14 to 104 °F) |
| Transportation temperature | -20 to +55 °C (-4 to +131 °F) | -20 to +55 °C (-4 to +131 °F) | -20 to +55 °C (-4 to +131 °F) | -20 to +55 °C (-4 to +131 °F) |
| Continual sound pressure at no-load | <70 dB | <70 dB | <70 dB | <70 dB |
| Dimensions l × w × h | 403×153×264 mm (15.8×6×10.4 in.) | | 403×153×264 mm (15.8×6×10.4 in.) | |
| Weight | 8.4 kg | | 8.4 kg | |
| Insulation class transformer | F | | F | |
| Enclosure class | IP23S | | IP23S | |
| Application class | S | | S | |

Mains supply, $S_{sc \min}$

Minimum short circuit power on the network in accordance with IEC 61000-3-12.

Duty cycle

The duty cycle refers to the time as a percentage of a ten-minute period that you can weld or cut at a certain load without overloading. The duty cycle is valid for 40 °C / 104 °F, or below.

Enclosure class

The **IP** code indicates the enclosure class, i.e. the degree of protection against penetration by solid objects or water.

Equipment marked **IP23S** is intended for indoor and outdoor use; however, should not be operated in precipitation.

Application class

The symbol **S** indicates that the power source is designed for use in areas with increased electrical hazard.

4 INSTALLATION

The installation must be carried out by a professional.



CAUTION!

This product is intended for industrial use. In a domestic environment this product may cause radio interference. It is the user's responsibility to take adequate precautions.

4.1 Location

Position the power source so that cooling air inlets and outlets are not obstructed.

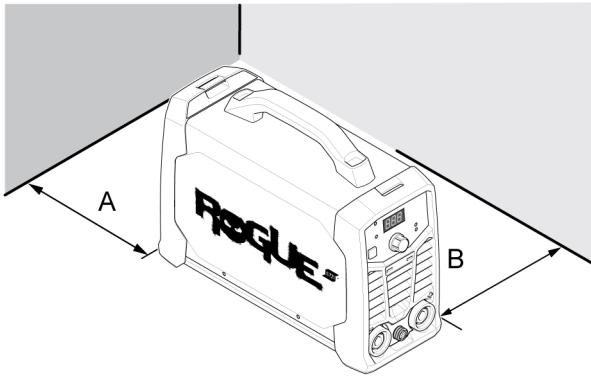

A. Minimum 200 mm (8 in.)

B. Minimum 200 mm (8 in.)



WARNING!

Secure the equipment - particularly if the ground is uneven or sloping.

4.2 Lifting instructions

These units are equipped with a handle for carrying purposes.



WARNING!

Electric shock can kill. Do not touch live electrical parts. Disconnect input power conductors from de-energized supply line before moving the welding power source.



WARNING!

Falling equipment can cause serious personal injury and equipment damage.

Lift the unit with handle on top of case.

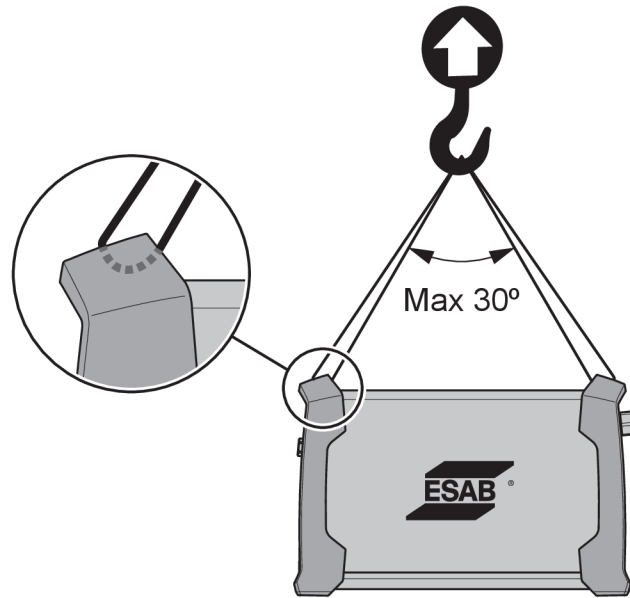

4.3 Mains supply



NOTE!

Rogue ES 181iP PRO and ES 201iP PRO complies with IEC 61000-3-12 provided that the short-circuit power is greater than or equal to S_{scmin} at the interface point between the user's supply and the public system. It is the responsibility of the installer or user of the equipment to ensure, by consultation with the distribution network operator if necessary, that the equipment is connected only to a supply with a short-circuit power greater than or equal to S_{scmin} . Refer to the technical data in the TECHNICAL DATA chapter.

The power source will automatically adjust to the supplied input voltage. Make sure that it is protected by the correct fuse rating. A protective ground connection must be made, in accordance with regulations.

1. Rating plate with supply connection data.

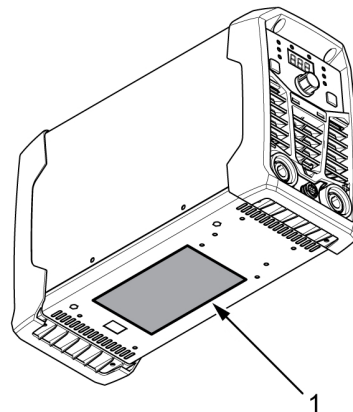

| Recommended fuse sizes and minimum cable area for the ES 181iP PRO, ES 201iP PRO | | |
|--|---------------------|---------------------|
| Supply voltage | 230 VAC | 115 VAC |
| Electrical cable area | 2.5 mm ² | 2.5 mm ² |
| Maximal current rating I_{max} | 30 A | 29 A |
| MMA / SMAW / Stick | | |
| I_{1eff} MMA / SMAW / Stick | 15 A | 14.5 A |

| Recommended fuse sizes and minimum cable area for the ES 181iP PRO, ES 201iP PRO | | |
|---|-------------------|-------------------|
| Fuse anti-surge type D MCB | 20 A | 20 A |
| Maximum recommended extension cord length | 100 m | 100 m |
| Minimum recommended extension cord size | 4 mm ² | 4 mm ² |

**NOTE!**

Different variants of **ES 181iP PRO, ES 201iP PRO** is certified for different outlet voltages. Always refer to the rating plate for the specification of the power source in use.

**NOTE!**

Use the power source in accordance with the relevant national regulations.

Supply from power generators

The power source can be supplied from different types of generators. However, some generators may not provide sufficient power for the welding power source to operate correctly. Generators with Automatic Voltage Regulation (AVR) or with equivalent or better type of regulation, with rated power 7 kW, are recommended.

5 OPERATION

General safety regulations for handling the equipment can be found in the "SAFETY" chapter of this manual. Read it through before you start using the equipment!



NOTE!

When moving the equipment use intended handle. Never pull the cables.



WARNING!

Electric shock! Do not touch the workpiece or the welding head during operation!

5.1 Connections and control devices

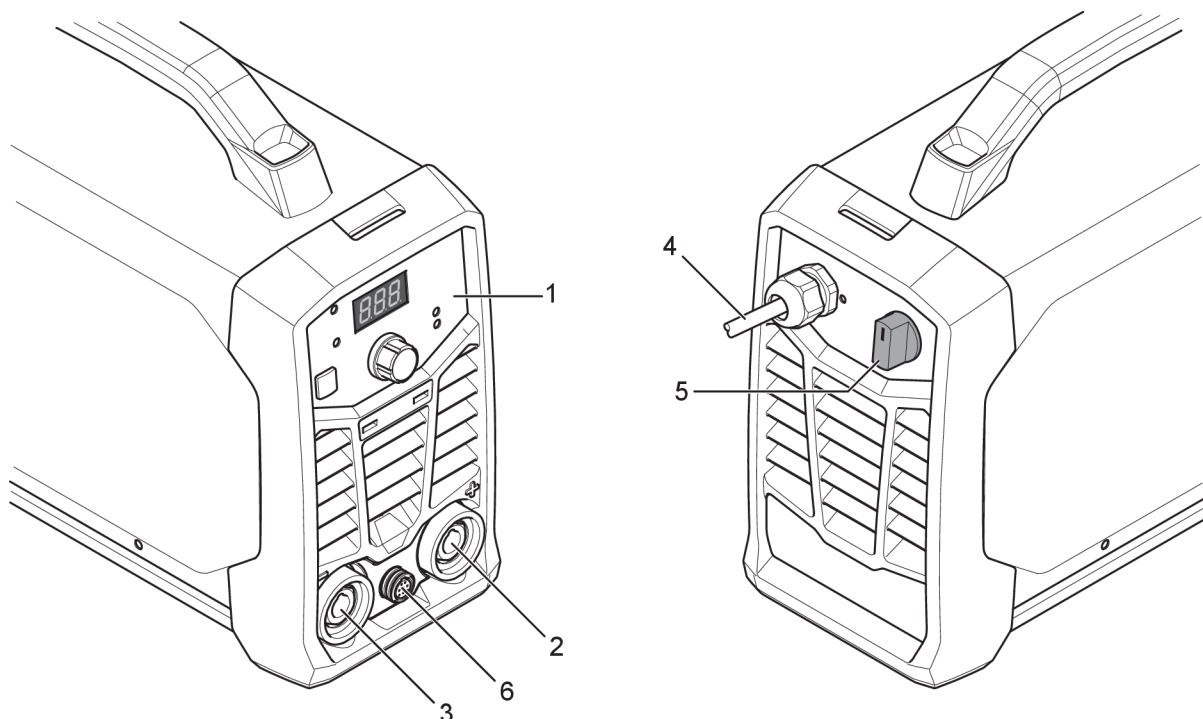

1. Setting panel
2. Positive welding terminal
3. Negative welding terminal

4. Power cable
5. Mains power supply switch, I/O
6. Remote socket

5.2 Connecting welding and return cables

The power source has two outputs, a positive welding terminal (+) and a negative welding terminal (-), for connecting welding and return cables. The output to which the welding cable is connected depends on the welding method or type of electrode used.

- For TIG / GTAW welding, the negative welding terminal (-) is used for the welding torch and the positive welding terminal (+) is used for the return cable.
- For MMA / SMAW / Stick welding, the welding cable can be connected to the positive welding terminal (+) or negative welding terminal (-), depending on the type of electrode used. The connection polarity is stated on the electrode packaging.

- 1) Connect the return cable to the other output on the power source.

- 2) Secure the return cable's contact clamp to the workpiece, and make sure that there is a good contact between the workpiece and the output for the return cable on the power source.

5.3 Turning the power on/off



CAUTION!

Do not turn off the power source during welding (with load).

- 1) Turn on the power by turning the switch to the "ON" (I) position.
- 2) Turn the unit off by turning the switch to the "OFF" (O) position.

Whether the power supply is interrupted or the power source is switched off in the normal manner, weld programs are stored so that they are available the next time the unit is started.

5.4 Fan control

The **Rogue ES 181iP PRO, ES 201iP PRO** is fitted with a fan as needed feature. Fan as needed automatically switches the cooling fan off when it is not required. This has two main advantages; (1) to minimize power consumption, and (2) to minimize the amount of contaminants such as dust that are drawn into the power source.



NOTE!

The fan only operates when required for cooling purposes and automatically switches off when not required.

5.5 Thermal protection



The power source includes thermal protection against overheating. When overheating occurs the welding is stopped and overheating indicator on the panel will be lit and an error message shows in the display. The protection is automatically reset when the temperature has been sufficiently reduced.

5.6 Functions and symbols



MMA / SMAW / Stick welding

MMA / SMAW / Stick welding may also be referred to as welding with coated electrodes. Striking the arc melts the electrode, and its coating forms protective slag.

For MMA / SMAW / Stick welding the power source shall be supplemented with:

- welding cable with electrode holder
- return cable with clamp

Arc force

Arc Force The arc force function determines how the current changes in response to variations in arc length during welding. Use a low value of arc force to get a calm arc with little spatter and use a high value to get a hot and digging arc.

Arc force only applies to MMA / SMAW / Stick welding.

Hot start

Hot Start The hot start function temporarily increases the current in the beginning of the weld. Use this function to reduce risk of insufficient fusion and electrode sticking and scratching.

Hot start only applies to MMA / SMAW / Stick welding.



TIG / GTAW welding

TIG / GTAW welding melts the metal of the workpiece, an arc initiated from a non-consuming tungsten electrode. The weld pool and electrode are protected by shielding gas.

For TIG / GTAW welding, the welding power source shall be supplemented with:

- a TIG / GTAW torch with gas valve
- an argon gas cylinder
- an argon gas regulator
- tungsten electrode

This power source performs **Live TIG start**

The tungsten electrode is placed against the workpiece. When lifted from workpiece, the arc is struck at a limited current level.

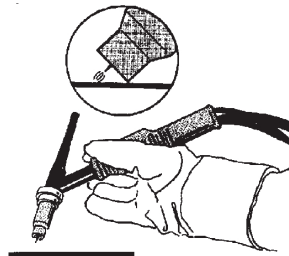
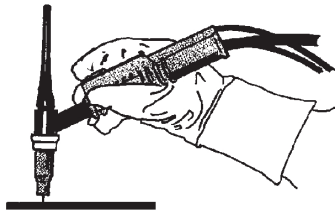

Voltage Reduction Device (VRD)

VRD

The VRD function ensures that the open-circuit voltage does not exceed 35 V when welding is not being carried out. This is indicated by a lit VRD indicator on the panel. Contact an authorised ESAB service technician to activate this function.



Pulse welding

Pulse welding is a technique used primarily to improve the control of the weld pool and the solidification process and minimize the material distortion by reducing the heat input. The pulsing of the current gives the weld pool time to solidify at least partially between each pulse. In order to set up pulsed welding it is required to define the parameters: peak current, pulse frequency, and background current. Pulse frequency range is 0.2-100Hz at MMA mode and 0.2-500Hz at TIG mode.

5.7 Setting panel

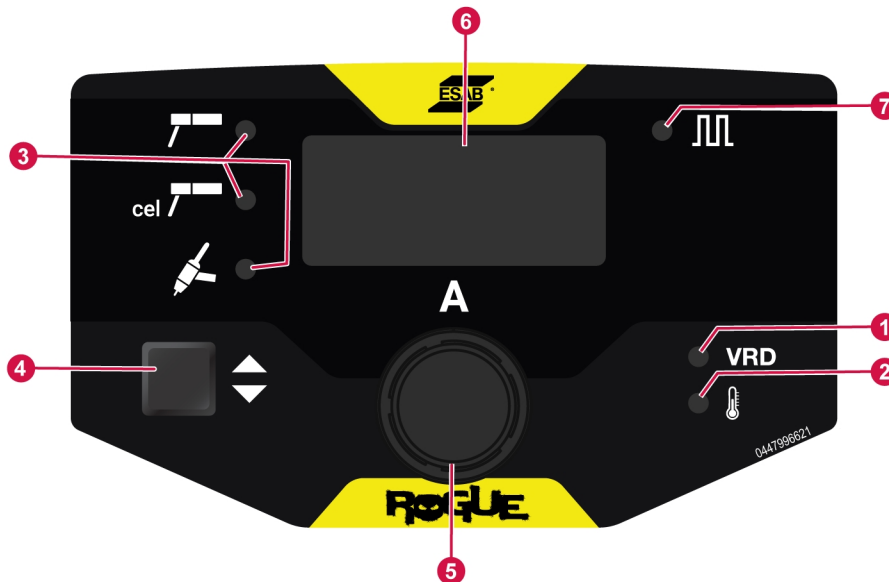

- | | |
|--|--|
| 1. VRD function (reduced open-circuit voltage) indicator | 5. Control knob – weld current/ Hot Start(HS)/ Arc Force(AF)/pulse control |
| 2. Overheating indication | 6. Display shows the set of measured value |
| 3. Indication of welding method: MMA / SMAW / Stick/ Cellulosic Electrode/ Live TIG / GTAW | 7. Pulse function indicator |
| 4. Process selection button | |

Process selection button (4):

- Use the button (4) to toggle between the welding methods.
- Press the button for 3 second to open advanced feature menu to select the required function. After the last selection, if left undisturbed for 5 seconds, the advanced features menu is exited. There are certain parameters in advanced features pertaining to pulse mode which can be accessed or adjusted only after turning on the pulse feature in the advanced features menu

Control knob (5):

- Use the control knob to control the welding current/ Hot Start(HS)/ Arc Force(AF)/ pulse.
- **In TIG / GTAW Live mode:**
 - Background current (BGR 10 - 100%)
- **In MMA / SMAW / Stick mode:**
 - Hot start (HS -10 - +10)
 - Arc force (AF -10 - +10)
 - Background current (BGR 60--80%)

5.8 Remote control

Connect the remote control to the front of the power source. When the remote control is connected, it is automatically activated. The maximum setting of the power source will be determined by the respective front panel control, irrespective of the remote control device setting.

6 MAINTENANCE

**WARNING!**

The mains supply must be disconnected during cleaning and maintenance.

**CAUTION!**

Only persons with the appropriate electrical knowledge (authorised personnel) may remove the safety plates.

**CAUTION!**

The product is covered by manufacturer's warranty. Any attempt to carry out repair work by non-authorised service centers or personnel will invalidate the warranty.

**NOTE!**

Regular maintenance is important for safe and reliable operation.

**NOTE!**





Perform maintenance more often during severe dusty conditions.

Before each use - make sure that:

- Product and cables are not damaged,
- The torch is clean and not damaged.

6.1 Routine maintenance

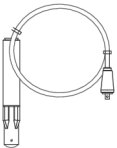
Maintenance schedule during normal conditions. Check equipment prior to every use.

| Interval | Area to maintain | | |
|----------------|--|---|--|
| Every 3 months |  Clean or replace unreadable labels. |  Clean weld terminals. |  Check or replace weld cables. |
| Every 6 months |  Clean inside equipment. Use dry compressed air with reduced pressure. | | |

6.2 Cleaning the power source

To maintain the performance and increase the lifetime of the power source it is mandatory to clean it regularly. How often depends on:

- The welding process
- The arc time

- The working environment



CAUTION!

Make sure that the cleaning procedure is done in a suitable prepared workspace.



CAUTION!

During cleaning, always wear recommended personal safety equipment, such as ear plugs, safety glasses, masks, gloves, and safety shoes.

- 1) Disconnect the power source from the mains supply.
- 2) Open the enclosure and use a vacuum cleaner to remove any accumulated dirt, metal filings, slag and loose material. Keep the shunt and lead screw surfaces clean as accumulated foreign material may reduce the welders output welding current.

7 TROUBLESHOOTING

Perform these checks and inspections before sending for an authorised service technician.

- Check that the mains voltage is disconnected before starting any type of repair action.

| Type of fault | Corrective action |
|---|---|
| MMA / SMAW / Stick welding problems | Check the welding process is set for MMA / SMAW / Stick. |
| | Check that the welding and return cables are correctly connected to the power source. |
| | Make sure that the return clamp has good contact with the workpiece. |
| | Check that the correct electrodes and polarity are being used. For polarity, check electrode packaging. |
| | Check that the correct Welding current (A) is set. |
| | Adjust Arc Force and Hot start. |
| TIG / GTAW welding problems | Check the welding process is set for Live TIG / GTAW as necessary. |
| | Check that the TIG / GTAW torch and return cables are correctly connected to the power source. |
| | Make sure that the return clamp has good contact with the workpiece. |
| | Make sure that the TIG / GTAW torch lead is connected to the negative welding terminal. |
| | Make sure that the correct shielding gas, gas flow, welding current, filler rod placement, electrode diameter and welding mode on power source is used. |
| | Make sure that the gas valve on the TIG torch is ON. |
| No arc | Check that the electrical power supply switch is turned on. |
| | Check that the display is on to verify that the power source has power. |
| | Check that the setting panel is displaying correct values. |
| | Check that welding and return cables are correctly connected. |
| | Check the electrical power supply fuses. |
| Welding current is interrupted during welding | Check whether the Over Temperature LED (Thermal Protection) on the setting panel is on. |
| | Continue with Troubleshooting "No Arc". |
| The thermal protection trips frequently | Make sure that the recommended duty cycle for the weld current has not been exceeded. |
| | Refer to power source "Duty cycle" in Section 3 "Technical data", page 9. |
| | Make sure that the air inlets or outlets are not clogged. |
| | Clean the inside of the machine using routine maintenance methods. |

8 ORDERING SPARE PARTS



CAUTION!

Repair and electrical work should be performed by an authorised ESAB service technician.
Use only ESAB original spare and wear parts.

The **Rogue ES 181iP PRO, ES 201iP PRO** are designed and tested in accordance with the international and European standards **EN60974-1** and **EN60974-10**. On completion of service or repair work, it is the responsibility of the person(s) performing the work to ensure that the product still complies with the requirements of the above standards.

Spare parts and wear parts can be ordered through your nearest ESAB dealer, see [esab.com](https://www.esab.com). When ordering, please state product type, serial number, designation and spare part number in accordance with the spare parts list. This facilitates dispatch and ensures correct delivery.

APPENDIX

DIAGRAM

For serial number HA427-xxxx-xxxx

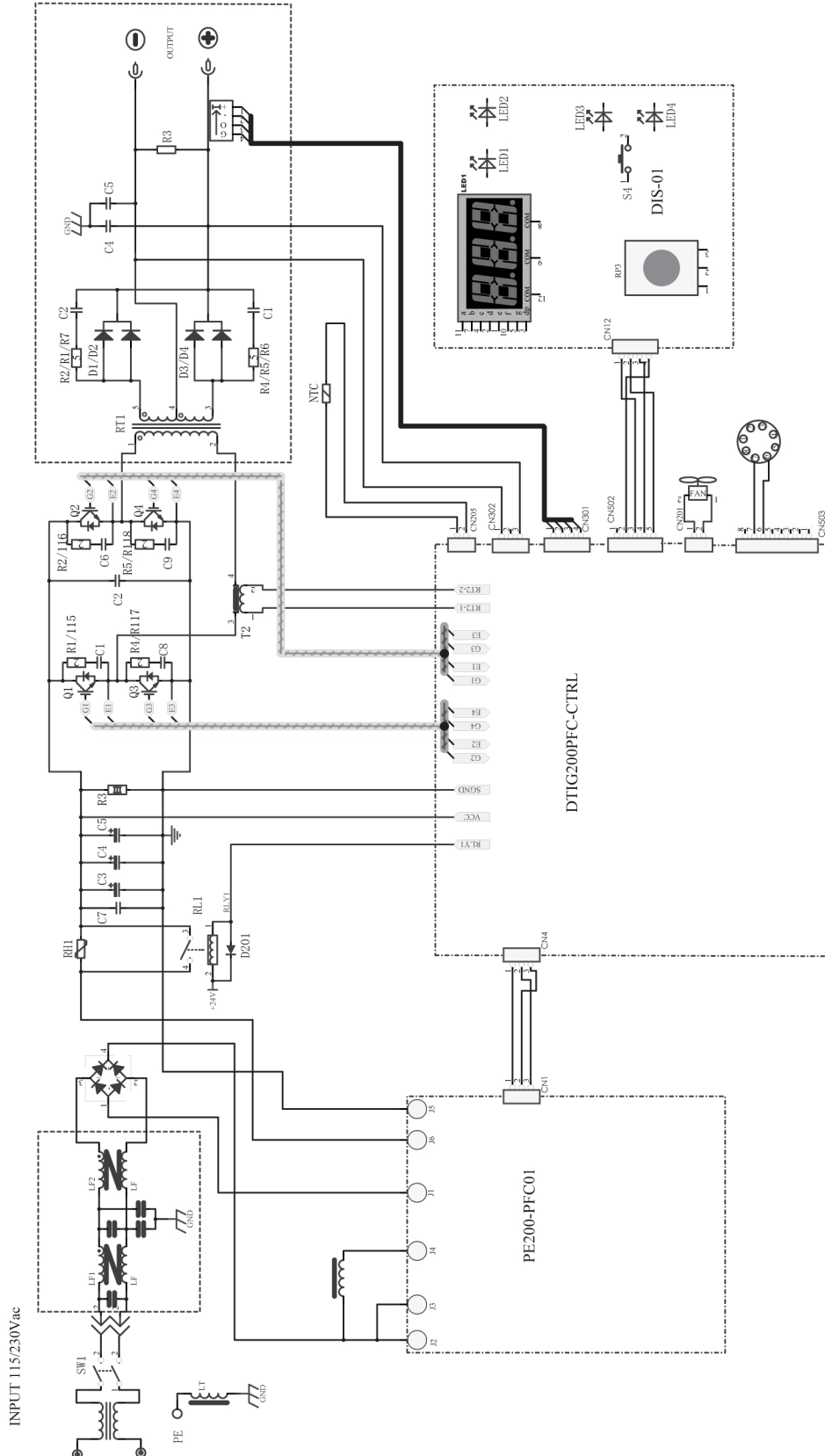

For serial number HA428-xxxx-xxxx

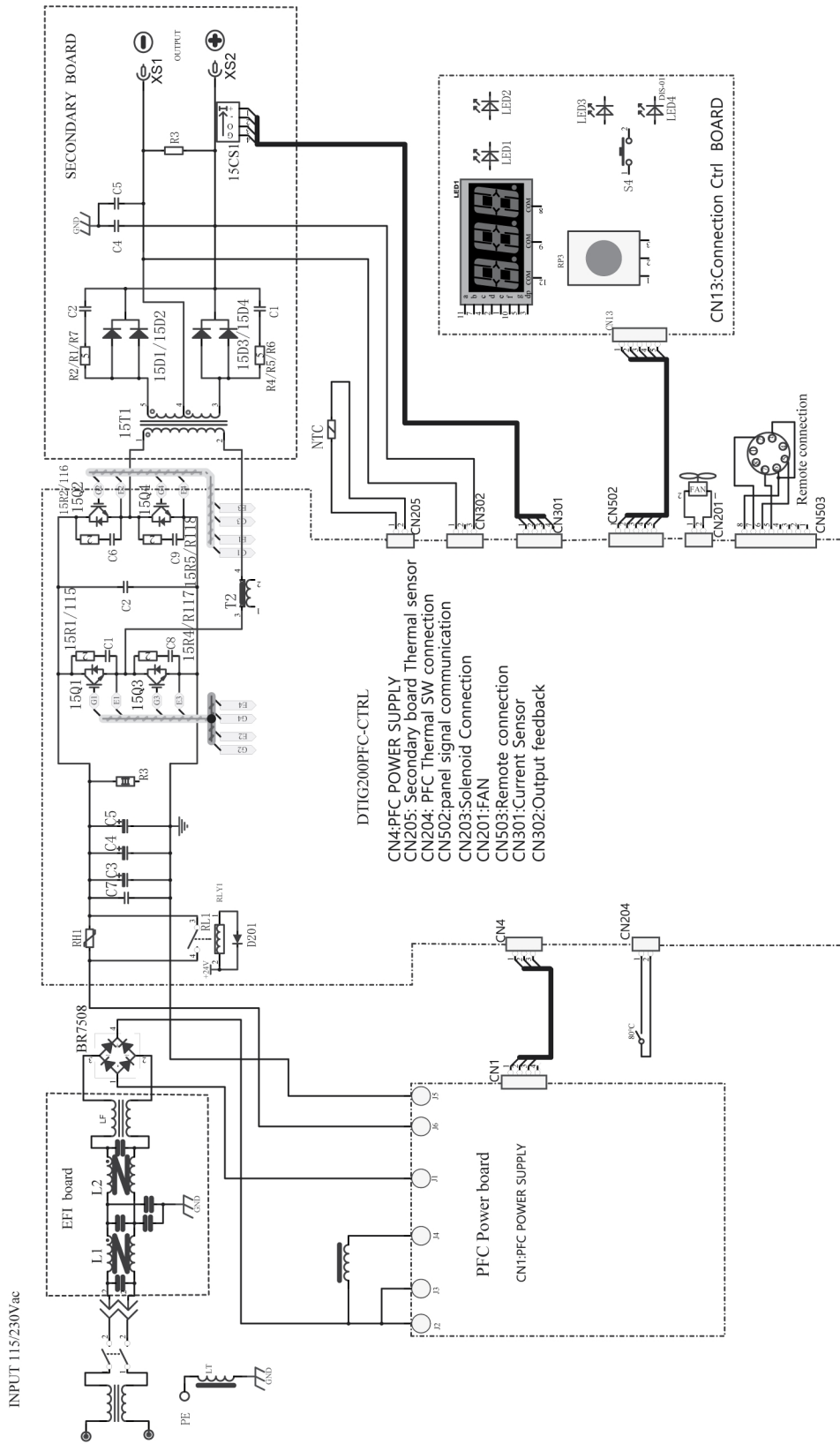

- CN4:PFC POWER SUPPLY
- CN205: Secondary board Thermal sensor
- CN204: PFC Thermal SW connection
- CN502:panel signal communication
- CN203:Solenoid Connection
- CN201:FAN
- CN503:Remote connection
- CN301:Current Sensor
- CN302:Output feedback

ORDERING NUMBERS

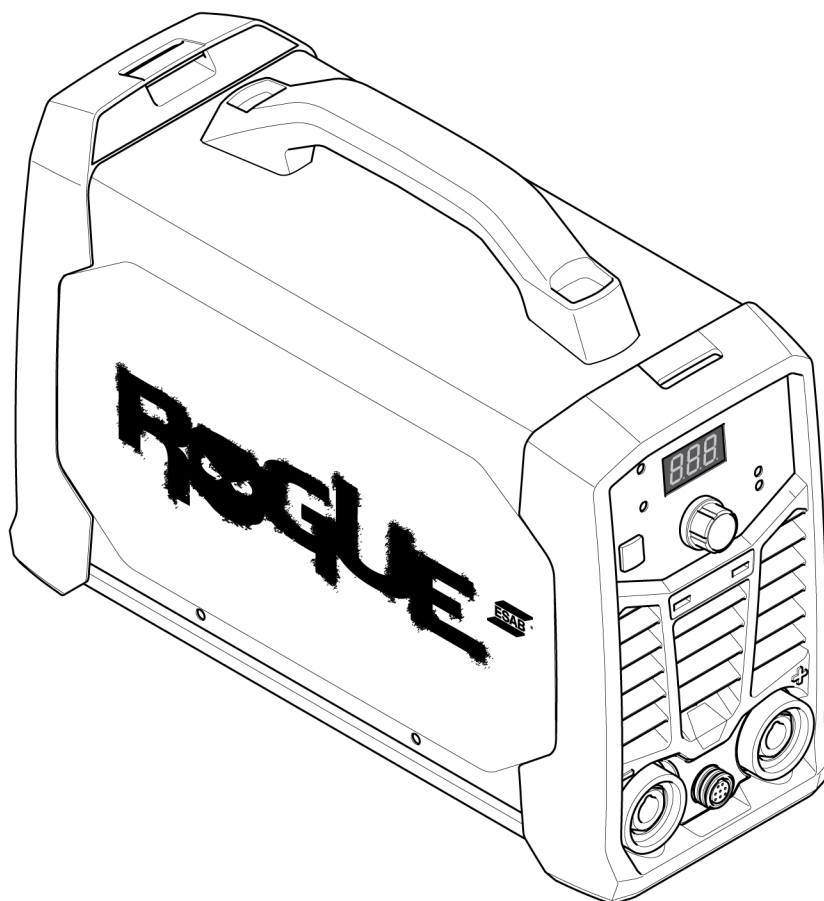



| Ordering number | Denomination | Type | Notes |
|-----------------|--------------------|--------------|-------------|
| 0705 002 007 | Power source | ES 181iP PRO | CE |
| 0705 002 009 | Power source | ES 201iP PRO | CE |
| 0705 002 014 | Power source | ES 201iP PRO | Middle East |
| 0705 002 012 | Power source | ES 201iP PRO | India |
| 0705 002 024 | Power source | ES 201iP PRO | SEA |
| 0448 526 * | Instruction manual | | |

The three last digits in the document number of the manual show the version of the manual. Therefore they are replaced with * here. Make sure to use a manual with a serial number or software version that corresponds with the product, see the front page of the manual.

Technical documentation is available on the Internet at: www.esab.com

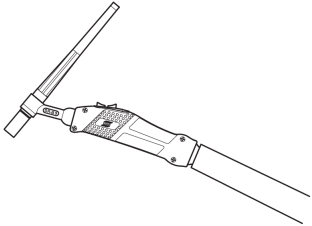
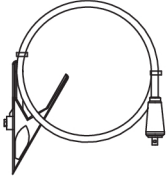
ACCESSORIES

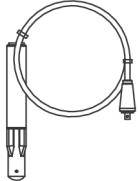
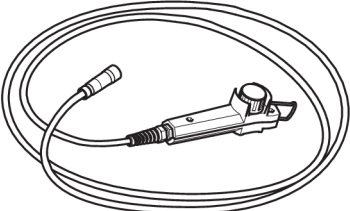
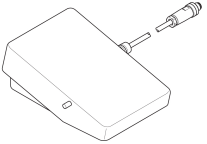
| TIG / GTAW torches | |  |
|---------------------------|---|---|
| 0700 025 514 | SR-B 17V, OKC 50, 4 m | |
| 0700 025 522 | SR-B 26V, OKC 50, 4 m | |
| Return cable kits | |  |
| 0700 006 889 | Return cable kit, OKC 50, 5 m | |
| 0700 006 903 | Return cable kit, OKC 50, 3 m | |
| 0160 360 881 | OKC 50 male cable connector, 1/0-4/0 cable (50 mm ²) EU |  |
| 0700 006 900 | Electrode holder Handy 200A with 25 mm ² , 3 m, OKC 50 |  |
| 0700 500 084 | Remote control, Handheld remote, MMA / SMAW / Stick 4 |  |
| W4014450 | Remote control, Foot pedal, with 4,5 m (15 ft) cable, 8 PIN |  |

APPENDIX

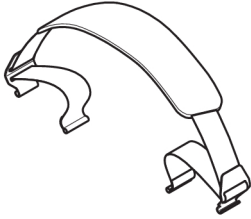
| | | |
|--------------|------------------------------|---|
| 0700 500 085 | Rogue plastic case (Toolbox) |  |
| 0700 500 086 | Shoulder strap |  |



A WORLD OF PRODUCTS AND SOLUTIONS.



For contact information visit <http://esab.com>

ESAB AB, Lindholmsallén 9, Box 8004, 402 77 Gothenburg, Sweden, Phone +46 (0) 31 50 90 00

manuals.esab.com

